

▼ Shown: EPHR-110



- Patented 'Safety Cage' jaw retention system
- High force hydraulic system for effortless pulling of large components
- Slim tapered jaws for better gripping in tight spots
- Available in 2 and 3 jaw design
- More efficient pulling, as one man can do the job where manual pullers often require two operators



◀ An EPHR-116, 50 ton hydraulic Posi Lock® puller easily removes the main drive gear from this metal forming brake press.

High-Tech Pulling



Transport and Store

Conveniently stores and transports hydraulic pullers and accessories.

Order the **EPT-2550** Storage Cart and make your job easier to do!



Long Jaws

Used to increase the reach and spread of pullers. They maintain the same pulling capacity as the standard jaws, but reduce clamping force to 25%.

Page: 147



Application Tip

Because of the unique safety cage design, Posi Lock® pullers will grip on surfaces where normal pullers would slip off; e.g. tapered bearings.



Visit the **Products** section of our web site for more information and product selection charts regarding puller sets and individual puller component parts.

www.enerpac.com

Number of Jaws	Maximum Spread	Capacity	Model Number*
	(mm)	ton (kN)	
2	304	10 (101)	EPH-208
3	304		EPH-108
2	381	15 (142)	EPH-210
3	381		EPH-110
2	457	25 (232)	EPH-213
3	457		EPH-113
2	635	50 (498)	EPH-216
3	635		EPH-116

* Cylinder is not included.

Posi Lock® Hydraulic Grip Pullers

▼ SETS SELECTION CHART

Style	Capacity (ton)	Basic Puller	Cylinder	Stroke (mm)	Pump Set	Set Model Number*	 (kg)
2 Jaw Puller	10	EPH-208	RC-106	152	-	EPHR208	10
	10	EPH-208	RC-106	152	EP-1E	EPHS208E	27
	15	EPH-210	RC-1510	254	-	EPHR210	22
	15	EPH-210	RC-1510	254	EP-1E	EPHS210E	38
	25	EPH-213	RC-2514	362	-	EPHR213	44
	25	EPH-213	RC-2514	362	EP-1E	EPHS213E	53
	50	EPH-216	RC-5013	336	-	EPHR216	87
50	EPH-216	RC-5013	336	EP-2E	EPHS216E	123	
3 Jaw Puller	10	EPH-108	RC-106	152	-	EPHR108	11
	10	EPH-108	RC-106	152	EP-1E	EPHS108E	28
	15	EPH-110	RC-1510	254	-	EPHR110	23
	15	EPH-110	RC-1510	254	EP-1E	EPHS110E	39
	25	EPH-113	RC-2514	362	-	EPHR113	48
	25	EPH-113	RC-2514	362	EP-1E	EPHS113E	57
	50	EPH-116	RC-5013	336	-	EPHR116	91
	50	EPH-116	RC-5013	336	EP-2E	EPHS116E	127

* Standard set EPHS models shipped with 230 VAC pump.

EPH Series



Capacity:

10-50 ton

Maximum Reach:

203-355 mm

Spread Range:

19-635 mm

Maximum Operating Pressure:

700 bar







Pump Sets

All Posi Lock Hydraulic Puller Sets that include 230 VAC pumps, will feature the following components:

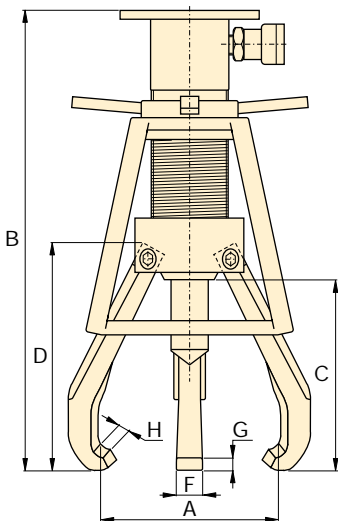
	EP-1E Pump Set	EP-2E Pump Set
Pump	PUJ-1200E	GPEM-3210E
Hose	HC-7210	HC-7210
Gauge	G-2536L	G-2536L
Adaptor	-	GA-3



Components for 115 VAC pumps are available on request.



Dimensions (mm)							 (kg)	Model Number*	Optional Accessories ¹⁾		
Spread min. - max.	Overall Length	Maximum Reach	Jaw Length	Jaw Width	Tip Clearance	Tip Depth					
A	B	C	D	F	G	H					
19 - 304	498	203	237	22	7,4	6,9	6,4	EPH-208	-	-	-
19 - 304	498	203	237	22	7,4	6,9	7,3	EPH-108	-	-	-
25 - 381	665	245	270	25	11,2	9,1	10,0	EPH-210	EPH-155	EPH-11054L	EPH-11052
25 - 381	665	245	270	25	11,2	9,1	11,3	EPH-110	EPH-155	EPH-11054L	EPH-11052
63 - 457	846	304	348	31	12,9	9,7	21,3	EPH-213	EPH-257	EPH-11354L	EPH-11352
63 - 457	846	304	348	31	12,9	9,7	25,0	EPH-113	EPH-257	EPH-11354L	EPH-11352
76 - 635	919	355	413	36	15,0	11,7	40,8	EPH-216	EPH-508	EPH-21654L	EPH-11652
76 - 635	919	355	413	36	15,0	11,7	45,4	EPH-116	EPH-508	EPH-11654L	EPH-11652

¹⁾ See next page for details.

▼ RAM POINT SETS SELECTION CHART

Fits Puller Set Model Number	EPH-210 EPH-110	EPH-213 EPH-113	EPH-216 EPH-116
			
Ram Point Set Model Number	EPH-155	EPH-257	EPH-508
Ram Points Included:	Ram Point Dimensions Diameter x Length (mm)		
Flat Ram Points	ø25 x 25	ø38 x 57	ø51 x 76
	ø25 x 76	ø51 x 57	ø70 x 76
	-	ø51 x 102	ø70 x 127
Tapered Ram Points	ø25 x 38	ø38 x 64	ø51 x 95
	ø25 x 89	ø51 x 64	ø51 x 95
	-	ø51 x 114	ø70 x 140
Ram Point Adaptor	-	-	ø70 x 57



Always wear Safety Goggles while using pullers.



Visit the **Products** section of our web site for more information and product selection charts regarding puller sets and individual puller component parts.
www.enerpac.com



▼ LIFT PLATE SELECTION CHART

Fits Puller Set Model Number	Model Number *	Thickness (mm)	Diameter (mm)
EPH-210	EPH-11052	6,4	ø153
EPH-110	EPH-11052	6,4	ø153
EPH-213	EPH-11352	9,7	ø203
EPH-113	EPH-11352	9,7	ø203
EPH-216	EPH-11652	9,7	ø254
EPH-116	EPH-11652	9,7	ø254



* Mounting screws included.

◀ *EPH-116 used to remove electric motor pulleys. Puller is positioned using the Lift Plate.*

▼ LONG JAW SELECTION CHART

Fits Puller Set Model Number	Model Number	Number of Jaws required	Spread (mm)	Reach (mm)	Weight (kg)
EPH-210	EPH-11054L	2	38 - 559	401	2,5
EPH-110	EPH-11054L	3	38 - 559	401	2,5
EPH-213	EPH-11354L	2	38 - 762	508	4,8
EPH-113	EPH-11354L	3	38 - 762	508	4,8
EPH-216	EPH-21654L	2	50 - 965	635	7,5
EPH-116	EPH-11654L	3	50 - 965	635	7,5



Long Jaws are used for added reach and spread. They have the same load capacity as standard jaws with 25% of the clamping force.